

## 21.5" & 27" Industrial Panel PC



### Product Features

- ◆ Intel's latest 12th Gen embedded CPUs: N97 & Core-i3 N305.
- ◆ Unleash the full power of the newest CPUs with DDR5 RAM.
- ◆ Aesthetically blend into any retail and industrial settings.
- ◆ Ultra-thin borders for broader and cleaner viewing.
- ◆ Robust, all-metal housing meets all retail and industrial demands.
- ◆ Fanless and non-mechanical components ensure optimal reliability.
- ◆ Dual 2.5Gbps LAN for enhanced network flexibility and security.
- ◆ USB-C Alt DP Mode: A single cable solution for video, audio, data, and power.
- ◆ IP54 front panel ingress protection.

## Features

### Intel's Cutting Edge CPU

12th Gen  
10nm  
Technology

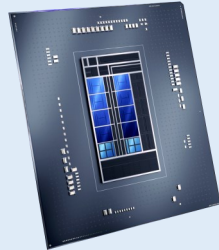

\* Intel is a registered trademark of Intel Corp.

### DDR5 RAM

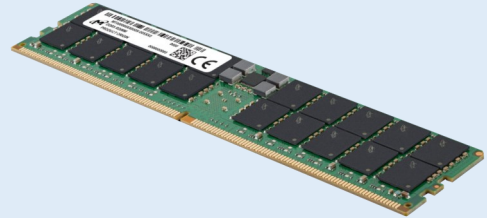

### USB-C Alt DP Mode

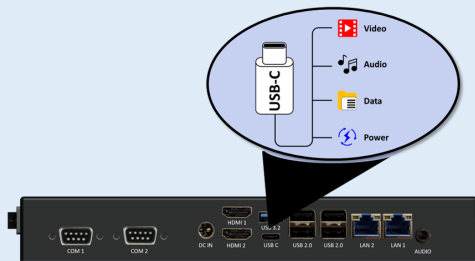

### Dual 2.5Gbps LAN



### IP54 Front Panel



### Slim & Stylish

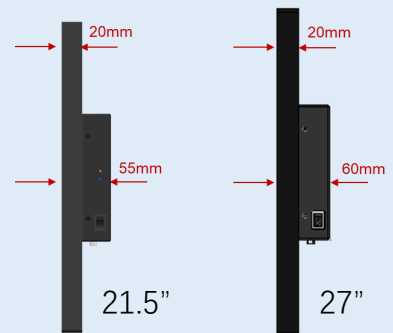

### Broader & Cleaner View

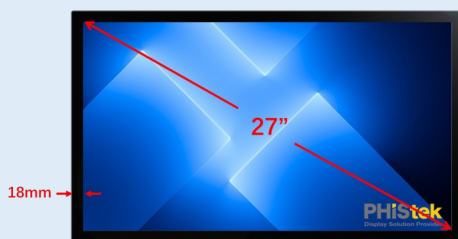

### VESA Mountings



Dimensions

PPC215

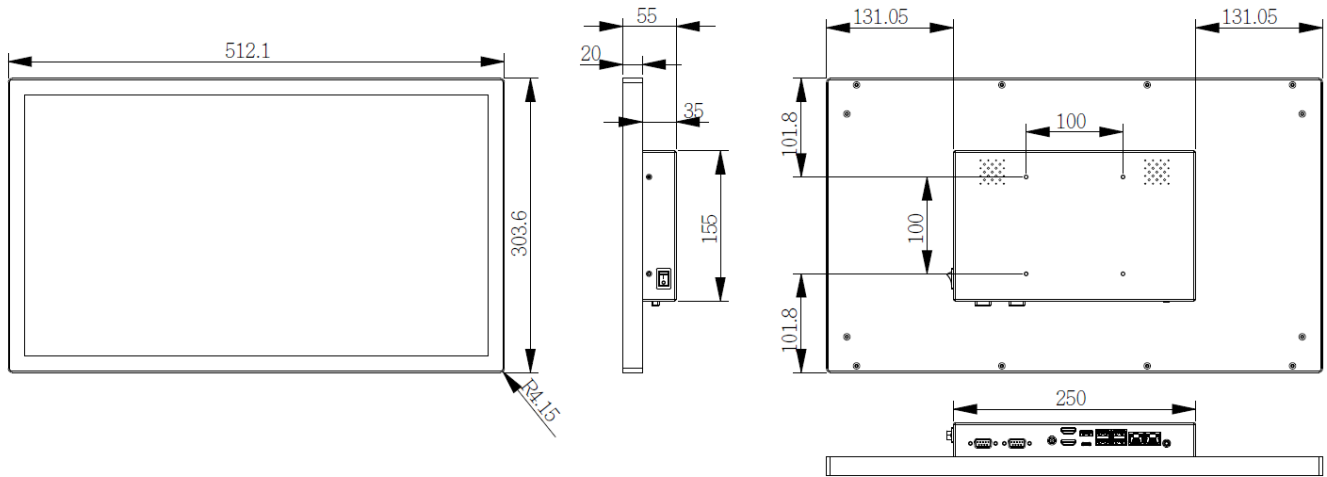
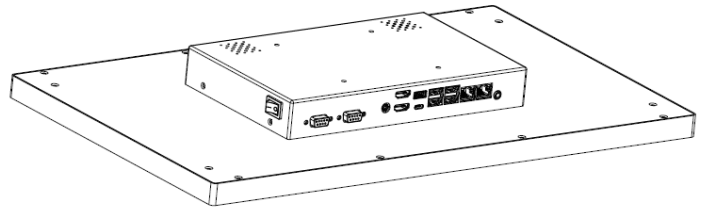

PPC270

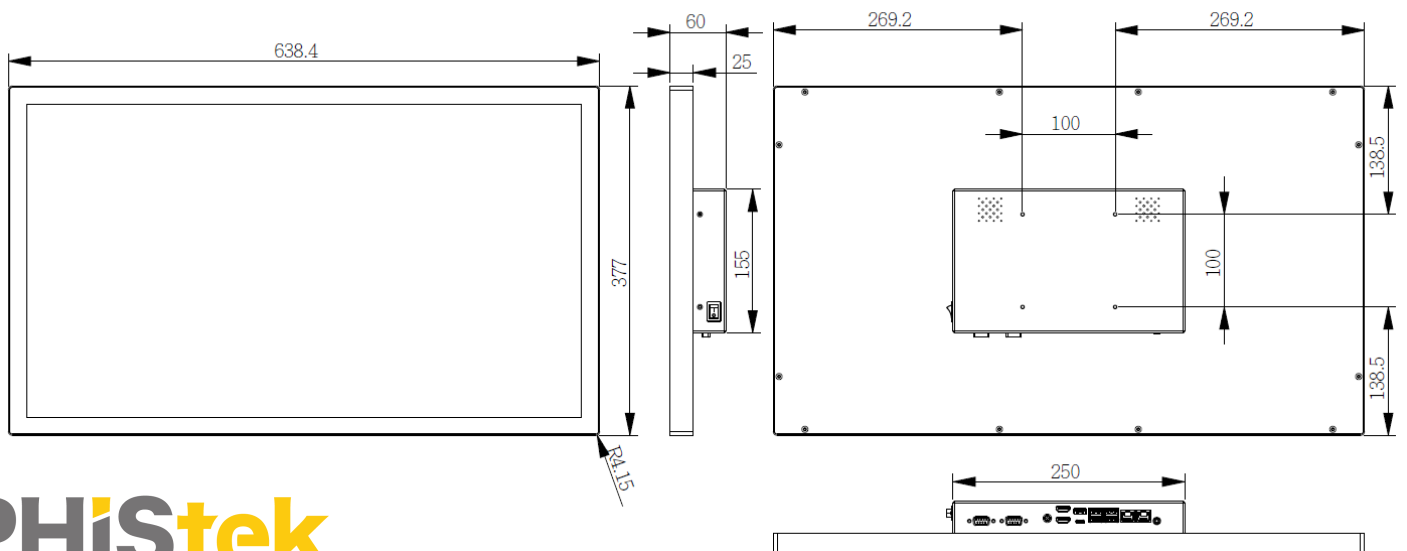
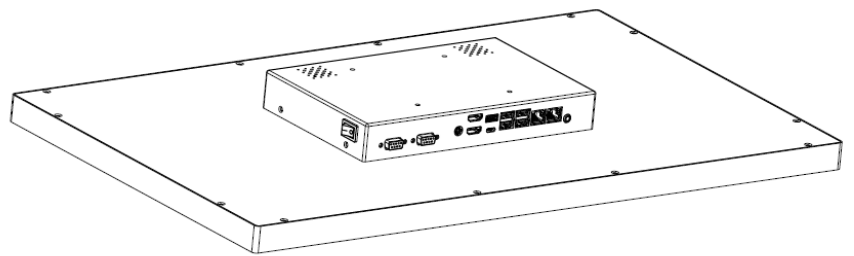

## Technical Specifications

Model		PPC215	PPC270
CPU		Intel Alder Lake <b>N97</b> (4-Core, 3.6GHz) / <b>N305</b> (8-Core, 3.8GHz)	
System Memory		1 x DDR5, SO-DIMM (Max. 16GB)	
Graphic		Intel UHD Graphics, 1.2GHz	
Storage	SSD	1 x M.2 (Max. 512GB)	
LCD	Size	21.5" TFT LCD	27" TFT LCD
	Resolution	1920 * 1080	1920 * 1080
	Brightness	350 cd/m2 (Typ.)	400 cd/m2 (Typ.)
	Contrast Ratio (Typ.)	3000:1	
	Viewing Angles (H/V)	178° / 178°	
	MTBF	30,000 hrs (Min.)	
Touch Screen	Type	10 Points Projected Capacitive	
External I/O Port		1 * USB 3.2	
		4 * USB 2.0	
		1 * USB-C (Alternate DP Mode)	
		2 * RS232	
		2 * HDMI	
		2 * LAN (RJ45, 2.5GbE Intel I225V)	
		1 * Audio (3.5mm, Mic/Spk Combo Jack)	
		1 * DC-In (5.5*2.5mm, Support 12~36VDC)	
		1 * Power Rocker Switch	
Speaker	2 * 3Watt		
Power		External AC Power Adapter	
Environmental	Operating Temperature	0°C ~ 40°C	
	Storage Temperature	-20°C ~ 60°C	
	Operating Humidity	20% ~ 85% RH non-condensing	
	Storage Humidity	20% ~ 85% RH non-condensing	
Housing		Metal	
OS Support		Windows® 10, 11, Linux 4.0 Kernel	
Dimension (W x D x H)		512.3 * 303.8 * 55 mm	638.4 * 377 * 60 mm
Weight (N.W./G.W.)		5Kgs / 6Kgs	7Kgs / 8Kgs
Wall Mount		VESA 100 * 100 mm	

\* Specification is subject to change without prior notice.